





A. Vraniczanya 5, 47000 Karlovac - HR  
Tel. ++385 (0)47 611 061; 601 091  
Fax ++385 (0)47 601-092  
GSM: ++385 (0)98 247 107; ++385 (0)99 21 31 640

Poduzeće "Lumakk" d.o.o. je višegodišnji zastupnik tvrtke „Besam“ u Hrvatskoj, što podrazumijeva kvalitetnu i pravovremenu nabavu, montažu i servis od strane educiranog i iskusnog tima serviser.

- direktor poduzeća je gđica Ksenija Kasunić, gsm: ++385 (0)99 21 31 640

- prodaja, kontakt osoba- Kruno Kasunić, gsm: ++385 (0)98 24 71 07

Zahvaljujući kvalitetnim "Besam"-ovim proizvodima poduzeće "Lumakk" d.o.o. je uspješno realiziralo više projekata s reprezentativnim klijentima.



Baumax, Jankomir



City Centar One, Jankomir



Kika, Jankomir



Lidl, Karlovac



Interspar, Jankomir



Mercedes Euroline, Zagreb



VW-Porsche, Jankomir

# Vrteća vrata

## 2-krila UniTurn



### Primjena

Zgrade s velikim protokom prometa i kontrolom klime u prostoru

- Područje transporta (zračne luke, željeznički kolodvori i sl.)
- Maloprodajni dućani
- Hoteli i restorani
- Zdravstvene ustanove

### Opcije

Klizna vrata  
Zakretna vrata  
Izlazi za nuždu

### Širina

3.6-5.4 m

### Ratings



## 3-4 krila RD3 i RD4



### Primjena

Objekti sa kontrolom klime u prostoru

- Javne ustanove
- Hoteli
- Područje transporta (zračne luke, željeznički kolodvori i sl.)
- Zdravstvene ustanove

### Opcije

Slim  
Frame  
Izlazi za nuždu

### Širina

1.8-3.6 m

### Ratings



## RD - Kontrola ulaza



### Primjena

Zgrade sa visoko sigurnosnim zahtjevima

- Državne ustanove
- Javne ustanove
- Elektrane, hidroelektrane i sl.
- Područje transporta (zračne luke, željeznički kolodvori i sl.)

### Opcije

Slim  
Frame  
Izlazi za nuždu

### Širina

1.8-2.1 m

### Ratings



 Kontrola klime u prostoru

 Protuprovalna zaštita

 Otpornost na mehanička oštećenja

 Propusnost kretanja

 Propusnost kretanja osoba s invaliditetom

# Klizna vrata

## Frame



### Primjena

Ulazi u

- Maloprodajne trgovine
- Područja transporta (zračne luke, željeznički kolodvori i sl.)
- Poslovne zgrade
- Zdravstvene ustanove

### Opcije

Teleskopska  
Izlaz za nuždu

### Širina okvira

0.9-6.0 m

### Ratings



## Frame Thermo



### Primjena

Ulazi u

- Maloprodajne trgovine
- Područje transporta (zračne luke, željeznički kolodvori i sl.)
- Poslovne zgrade
- Zdravstvene ustanove

### Opcije

Teleskopska  
Izlaz za nuždu

### Širina okvira

0.9-6.0 m

### Ratings



## Slim



### Primjena

Ulazi u

- Maloprodajne trgovine
- Područje transporta (zračne luke, željeznički kolodvori i sl.)
- Poslovne zgrade
- Zdravstvene ustanove

### Opcije

Teleskopska  
Izlaz za nuždu

### Širina okvira

0.9-6.0 m

### Ratings



 Kontrola klime u prostoru

 Protuprovalna zaštita

 Otpornost na mehanička oštećenja

 Propusnost kretanja

 Propusnost kretanja osoba s invaliditetom

# Klizna vrata

## Slim Thermo



### Primjena

Ulazi u

- Maloprodajne trgovine
- Područje transporta (zračne luke, željeznički kolodvori i sl.)
- Poslovne zgrade
- Zdravstvene ustanove

### Opcije

Teleskopska  
Izlaz za nuždu

### Širina okvira

0.9-6.0 m

### Ratings



## Semi Transparent



### Primjena

Ulasci i unutarnja vrata

- Maloprodajne trgovine
- Područje transporta (zračne luke, željeznički kolodvori i sl.)

### Opcije

Teleskopska  
Izlaz za nuždu

### Širina okvira

0.9-6.0 m

### Ratings

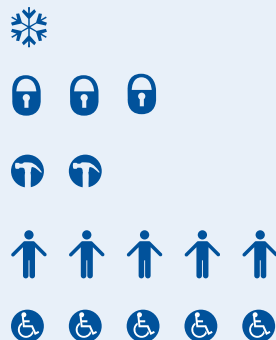

## Transparent



### Primjena

Ulasci i unutarnja vrata

- Maloprodajne trgovine
- Područje transporta (zračne luke, željeznički kolodvori i sl.)
- Poslovne zgrade

### Opcije

Izlaz za nuždu

### Širina okvira

0.9-6.0 m

### Ratings

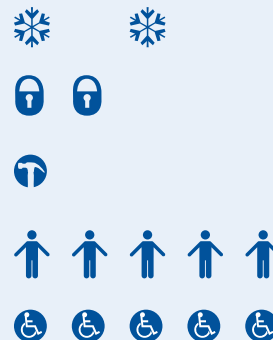

 Kontrola klime  
u prostoru

 Protuprovalna  
zaštita

 Otpornost na mehanička  
oštećenja

 Propusnost  
kretanja

 Propusnost kretanja  
osoba s invaliditetom

# Klizna vrata

## Zakrivljena klizna vrata



### Primjena

Objekti sa kontrolom klime u prostoru

- Poslovne zgrade
- Hoteli

### Opcije

Električni izlaz za nuždu

### Širina svijetlog otvora

1.005-2.6 m

### Ratings

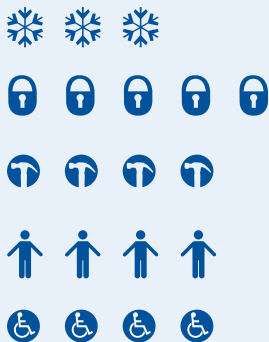

## Hermetička



### Primjena

Sterilni prostori u bolnicama  
Sterilni prostori u industriji  
Operacijske sale

### Opcije

Čelični inox paneli  
Dodatni prozor od zračenja

### Širina svijetlog otvora

0.8-2.5 m

### Ratings



## Upravljačke jedinice



### Primjena

Mogu biti integrirani kao dio sistema Besamovih automatskih vrata ali moguće je primjeniti i na vrata drugih proizvođača prema želji kupca.

### Opcije

UniSlide  
UniSlide Telescopic  
UniSlide Hermetic

### Širina svijetlog otvora

0.9-4.0 m

### Ratings



 Kontrola klime u prostoru

 Protuprovalna zaštita

 Otpornost na mehanička oštećenja

 Propusnost kretanja

 Propusnost kretanja osoba s invaliditetom

# Zakretna vrata

## IK-A/IKS-A



### Primjena

Idealna su za velika teška vrata i jake udare vjetra

- Maloprodajne trgovine

### Opcije

Push/Pull mogućnost  
Jednokrilna i dvokrilna izvedba  
Kompletna stijena s vratima

### Težina i dimenzije

IK-A = 100 kg, IKS-A = 250 kg max.

### Ratings

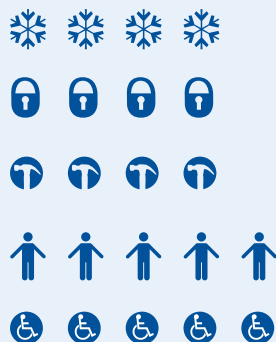

## PowerSwing



### Primjena

Push/Pull mogućnost  
Jednokrilna i dvokrilna

### Opcije

Push/Pull mogućnost  
Jednokrilna i dvokrilna izvedba  
Kompletna stijena s vratima

### Težina i dimenzije

250 kg max.

### Ratings

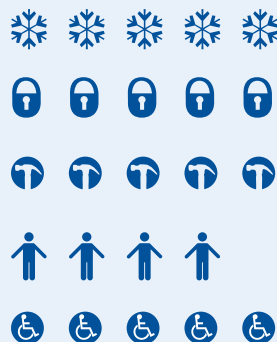

## OPB



### Primjena

Unutarnja zakretna vrata  
"light-traffic"

- Javni i privatni objekti

### Opcije

Push/Pull mogućnost  
Jednokrilna i dvokrilna izvedba

### Težina i dimenzije

100 kg

### Ratings

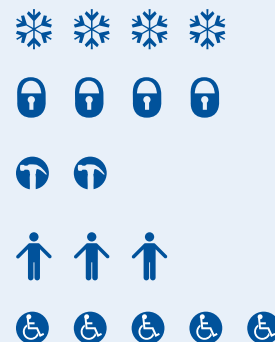

 Kontrola klime u prostoru

 Protuprovalna zaštita

 Otpornost na mehanička oštećenja

 Propusnost kretanja

 Propusnost kretanja osoba s invaliditetom

# Zakretna vrata

## Balansna vrata



### Application

Ulazi, uski prolazi i hodnici  
• Maloprodajne trgovine

### Opcije

Jednokrilna i dvokrilna izvedba

### Težina i dimenzije

80 kg - max. vratno krilo š. 1.05 m  
BDS-1 širina okvira 0,84-1.170 m  
BDS-2 širina okvira 1.560-2.4 m

### Ratings

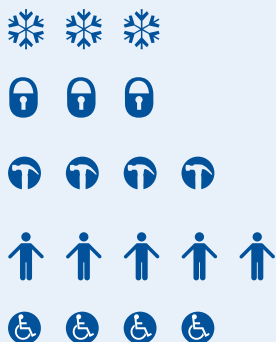

## Kontrole ulaza



### Application

Javni i privatni objekti

### Opcije

EGR - Entrance gates revolving (vrteća)  
EGS - Entrance gates swing (zakretna)

### Opcije

NA

### Ratings



 Kontrola klime u prostoru

 Protuprovalna zaštita

 Otpornost na mehanička oštećenja

 Propusnost kretanja

 Propusnost kretanja osoba s invaliditetom

# Zračne zavjese

## AD



## AD Corinte



### Primjena

Ulasci sa kliznim vratima

- Maloprodajne trgovine
- Javne ustanove
- Područje transporta (zračne luke, željeznički kolodvori i sl.)

### Opcije

Grijanje preko vruće vode  
Grijanje na struju  
Mikroklima prostora

### Detalji

AD 200: Horizontalna instalacija  
max 2.5 m visine  
1-2.0 m dužine

AD 300: Horizontalna instalacija  
max 3.5 m visine  
1-2.0 m dužine

AD Corinte: Horizontalna ili vertikalna instalacija  
max 3.0 m visina vrata  
2.2 ili 2.7 m visine

### Učinkovitost i investicija

AD 200	
AD 300	
AD Corinte	

## SF



## RD



### Primjena

Ulazi s vrtećim vratima

- 3-krila i 4-krila
- 2-krilni UniTurn

### Opcije

Grijanje preko vruće vode  
Grijanje na struju  
Mikroklima prostora

### Detalji

SF Vertikalna instalacija  
instalacija unutar otvora vrata

RD Standard maska, mogućnost  
izvedbe do spuštenog stropa

### Učinkovitost i investicija

SF	
RD	

**besam™** 

**ASSA ABLOY**

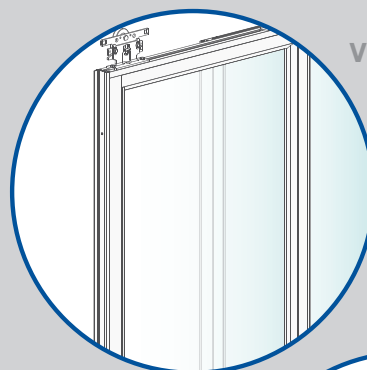

Vratno krilo

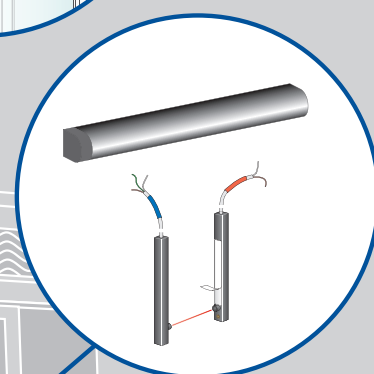

Sigurnosni senzori

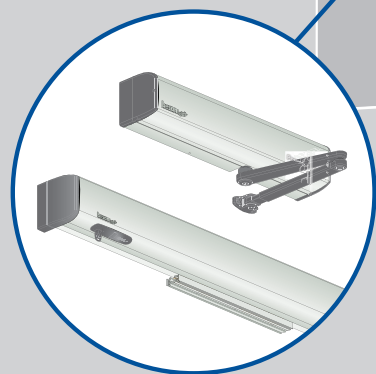

Upravljačke jedinice

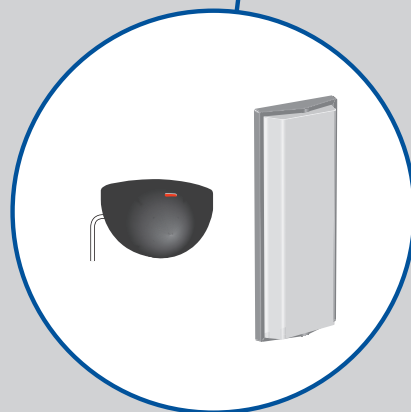

Aktivacijske jedinice

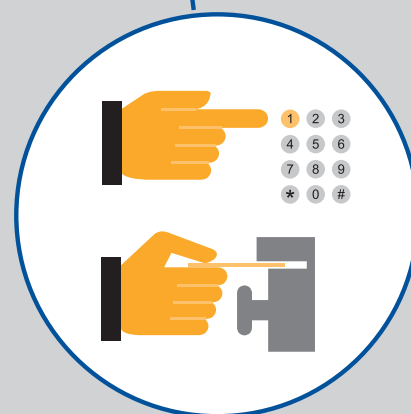

Uređaji za kontrolu ulaza

# Reference

## Neki od naših objekata

### TRGOVAČKI OBJEKTI

BAU MAX; GRAMAT; MERCATOR; KONZUM;  
PEVEC; KIKA; LIDL; MERKUR; KAPTOL- CENTAR;  
CITY CENTAR ONE; INTERSPAR; FEROTERM

### BENZINSKE POSTAJE

INA; OMW; PETROL

### AUTO KUĆE

AUTO- ZUBAK; HYUNDAI Zagreb;  
MERCEDES EUROLINE Zagreb;  
PORSCHE INTERAUTO Zagreb Split;  
ŠKODA; RENAULT Karlovac;  
PORSCHE Zagreb Jankomir

### HOTELI I RESTORANI

Hoteli BABIN KUK Dubrovnik;  
MALIN Malinska - Krk;  
MARIN Selce; GLOBO Split;  
ARISTOS Zagreb; MIKULIĆ Biograd;  
Hoteli BORIK Zadar; Hotel BOŽAVA Dugi Otok;  
Hotel DUGA RESA; Hotel EUROPA Karlovac;  
Hotel ROYAL Opatija; Hotel PICOK;  
Hotel AMFORA;  
Hotel NOVI RESORT Novi Vinodolski

### ZRAČNE LUKE

ZRAČNA LUKA SPLIT, ZRAČNA LUKA ZADAR

### ZDRAVSTVENE USTANOVE

BOLNICA Koprivnica; SESTRE MILOSRDNICE Zagreb

### BANKE

ERSTE & STEIERMÄRKISCHE BANK; HYPO-ALPE ADRIA;  
PBZ; REIFFEISEN BANK, KVARNER WIENER STÄDTISCHE BANK

### POSLOVNE, STAMBENE ZGRADE

EUROPA PRESS HOLDING; LAVČEVIĆ; NOVA GALERIJA Zagreb





A. Vraniczanya 5, 47000 Karlovac - HR  
Tel. ++385 (0)47 611 061; 601 091  
Fax ++385 (0)47 601-092  
GSM: ++385 (0)98 247 107; ++385 (0)99 21 31 640

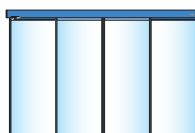
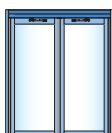

[www.besam.com](http://www.besam.com)

Besam is a part of ASSA ABLOY